

Distributed I/O Module 8 digital inputs communicating over RS-485

DAT 3148/8

FEATURES

- Modbus Server device on RS-485
- Modbus RTU/ Modbus ASCII protocol
- 8 digital inputs
- 8 counters 16 bit up to 100 Hz
- Watch-Dog alarm
- Four ways galvanic isolation
- CE / UL / UKCA mark
- DIN rail mounting in compliance with EN-50022



GENERAL DESCRIPTION

The device DAT 3148/8 is able to acquire up to 8 digital inputs. For each digital input it is implemented a 16 bit counter with maximum frequency of 100 Hz. The data are transmitted with MODBUS RTU/MODBUS ASCII protocol on the RS-485 network.

To ensure the plant safety, it is provided a Watch-Dog timer alarm.

The isolation between the parts of circuit removes eventual ground-loop effects, allowing the use of the device even in the heavy environmental conditions.

The device is in compliance with the Directive UL 61010-1 for US market and with the Directive CSA C22.2 No 61010-1 for the Canadian market.

It is housed in a rough self-extinguishing plastic container which, thanks to its thin profile of 17.5mm only, allows a high density mounting on EN-50022 standard DIN rail.

USER INSTRUCTIONS

Before to install the device, please read the "Installation Instruction" section.

If the module configuration is unknown, with device powered off, connect the INIT terminal to the GND terminal (ground), at the next power on the device will be auto-configured in the default settings (refer to the User Guide of the device).

Connect power supply, serial bus and digital inputs as shown in the "Wiring" section.

The "PWR" LED state depends on the working condition of the device: see the "Light Signalling" section to verify the device working state.

To perform configuration and calibration operations, read the instructions in the User Guide of the device.

To simplify handling or replacing of the device, it is possible to remove the wired terminals even with the device powered.

TECHNICAL SPECIFICATIONS (Typical @ 25 °C and in the nominal conditions)

DIGITAL INPUTS		SERIAL OUTPUT	GENERAL SPECIFICATIONS
Number of Channels	8	Data Transmission (asynchronous serial RS-485)	Power supply voltage 10 .. 30 Vdc
Input voltage (bipolar)	OFF State : 0±3 V ON State : 10±30 V	Baud Rate 115.2 Kbps	Reverse polarity protection 60 Vdc max
Input Impedance	4.7 KOhm	Max. distance 1.2 Km – 4000 ft	Max. Current consumption 35 mA
Sample time	5 ms		ISOLATION (test time 1 minute)
Counters 16 bit	8 up to 100 Hz		Inputs – RS485 2000 Vac 50 Hz
			Inputs – Supply 2000 Vac 50 Hz
			RS-485 – Supply 2000 Vac 50 Hz
			ENVIRONMENTAL CONDITIONS
			Operative temperature -10°C .. +60°C
			UL Operative Temperature -10°C .. +40°C
			Storage temperature -40°C .. +85°C
			Humidity (not condensing) 0 .. 90 %
			Maximum Altitude 2000 m slm
			Installation Indoor
			Category of Installation II
			Pollution Degree 2
			MECHANICAL SPECIFICATIONS
			Material Self-extinguish plastic
			IP Code IP20
			Wiring wires with diameter 0.8+2.1 mm ²
			AWG 14-18
			Tightening Torque 0.5 N m
			Mounting in compliance with DIN rail standard EN-50022
			Weight about 150 g.
			CERTIFICATIONS
			EMC (for the Industrial Environments)
			Immunity EN 61000-6-2
			Emission EN 61000-6-4
			UKCA (ref S.I. 2016 N°1091)
			Immunity BS EN 61000-6-2
			Emission BS EN 61000-6-4
			UL
			US Standard UL 61010-1
			Canadian Standard CSA C22.2 No 61010-1
			CCN NRAQ/NRAQ7
			Typology Open Type device
			Classification Industrial Control Equipment
			File Number E352854

INSTALLATION INSTRUCTIONS

The device is suitable to be mounted on DIN rail, in vertical position. For a correct working and a long life of the device, read the following indications. In case of the devices are mounted side by side, please leave about 5mm between if the temperature in the cabinet higher than 45 °C and high supply voltage (>27Vdc).

Avoid to place raceways or other objects which could obstruct the ventilation slits. It is suggested to avoid that devices are mounted above appliances generating heat; their ideal place should be in the lower part of the panel.

Avoid to install the devices in a site where vibrations are present. It is recommended to use shielded cable for connecting signals. The shield must be connected to an earth wire provided for this purpose. Moreover it is suggested to avoid routing conductors near power signal cables.

CABLING

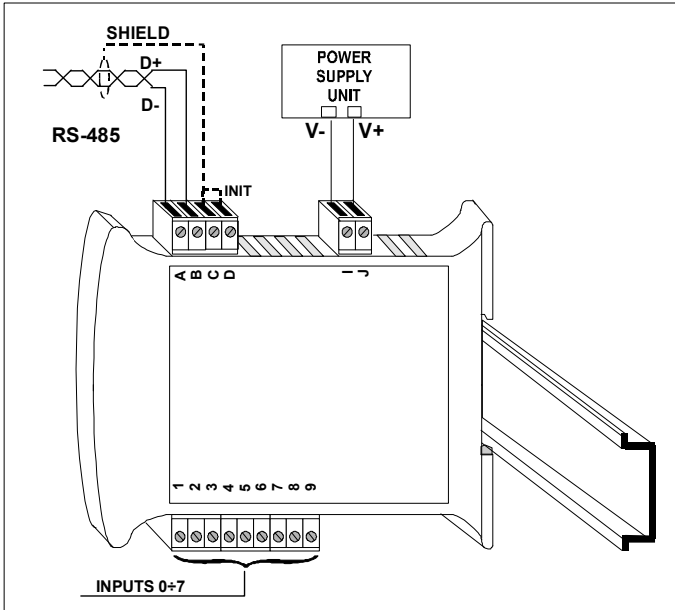

LIGHT SIGNALLING

LED	COLOR	STATE	DESCRIPTION
PWR	GREEN	ON	Device powered
		OFF	Device not powered / Wrong RS-485 cabling.
		FAST BLINKING	Communication in progress (the blinking frequency depends on baud-rate)
		1 second BLINKING	Watch-Dog Alarm condition

ISOLATION STRUCTURE

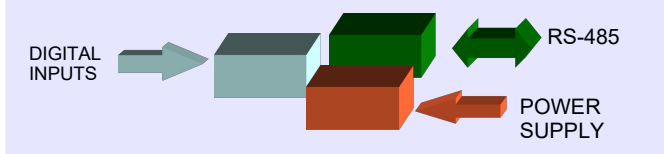

MECHANICAL DIMENSIONS (mm)

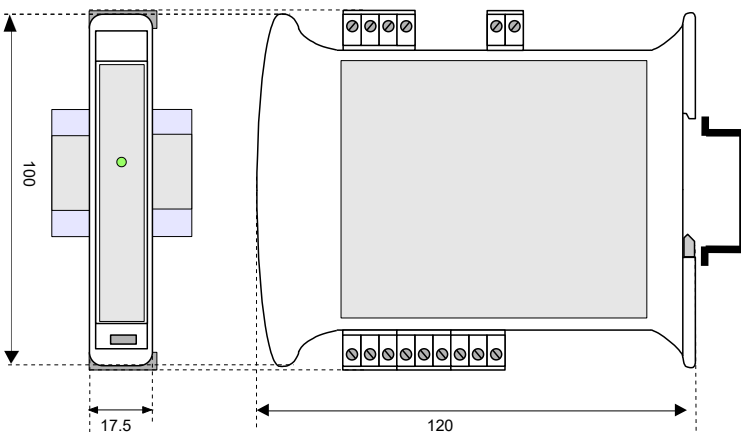

The symbol reported on the product indicates that the product itself must not be considered as a domestic waste. It must be brought to the authorized recycle plant for the recycling of electrical and electronic waste. For more information contact the proper office in the user's city, the service for the waste treatment or the supplier from which the product has been purchased.

WIRING

POWER SUPPLY (*)

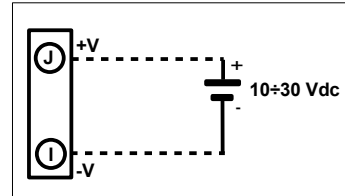

INIT

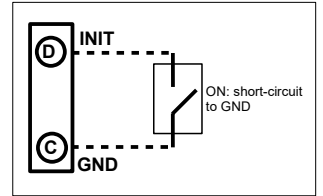

(*) Note: for UL installation the device must be powered using a power supply unit classified NEC class 2 or SELV with limited energy

DIGITAL INPUTS

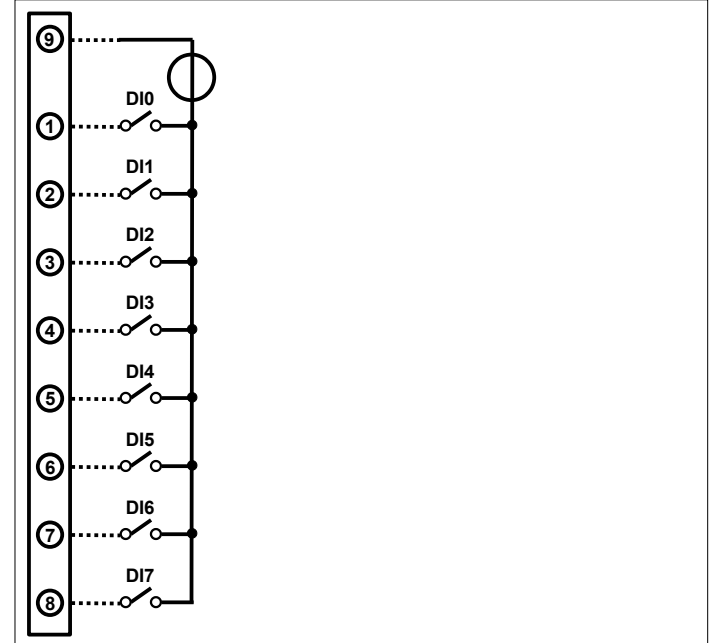

NOTES: Input channels are not insulated between them

RS-485

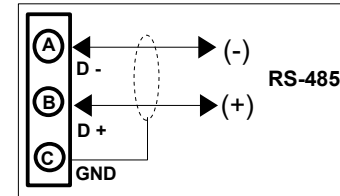

HOW TO ORDER

ORDER CODE:
DAT 3148/8